

## **TV-Free**

**Universal video-in-motion Interface**

## **CTVIMVW05**

## **High Speed VW CAN-Bus Vehicles**

### **Legal Information**

By law, watching moving pictures while driving is prohibited, the driver must not be distracted. We do not accept any liability for material damage or personal injury resulting, directly or indirectly, from installation or operation of this product. This product should only be used while standing or to display fixed menus or rear-view-camera video when the vehicle is moving, for example the MP3 menu for DVD upgrades.

## Contents

- 1. Prior to installation**
  - 1.1. Delivery contents
  - 1.2. Pin-assignments
- 2. Installation**
- 3. Specifications**

## 1. Prior to installation

Read the manual prior to installation. Technical knowledge is necessary for installation. The place of installation must be free of moisture and away from heat sources.

### 1.1. Delivery contents

*Take down the SW-version and HW-version of the interface-boxes, and store this manual for support purposes!*

HW \_\_\_\_\_ SW \_\_\_\_\_

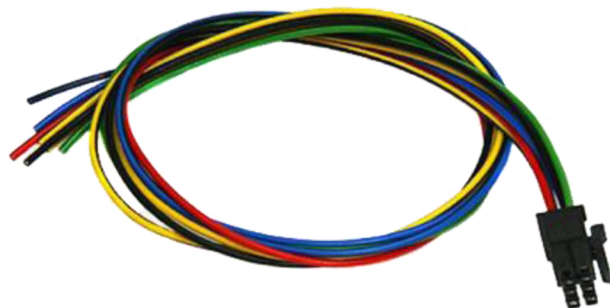

## 1.2. Pin-assignments

### Pin-assignment harness

Cable colour	Assignment
● Yellow	CAN-HIGH – toward the navigation unit
● Blue	CAN-LOW – toward the navigation unit
●● Yellow/Black	CAN-HIGH – toward the vehicle's harness
●● Blue/Black	CAN-LOW – toward the vehicle's harness
● Red	+12V permanent
● Black	Ground
● Green	Activation of the video-in-motion function (+12V = TV-free activated)

## 2. Installation

**Switch off ignition and disconnect the vehicle's battery! If according to factory rules disconnecting the battery has to be avoided, it is usually sufficient to put the vehicle in sleep-mode. In case the sleep-mode does not show success, disconnect the battery with a resistor lead.**

Install the interface at the CAN bus connection of the respective navigation system. Separate the two CAN BUS cables (CAN-HIGH and CAN-LOW) from the navigation system and connect them to harness supplied (see picture below).

Connect the **red wire** to **+12V permanent** and connect the **black wire** to **ground**. The **green wire** is used to **activate the video-in-motion function** (+12 V = activated).

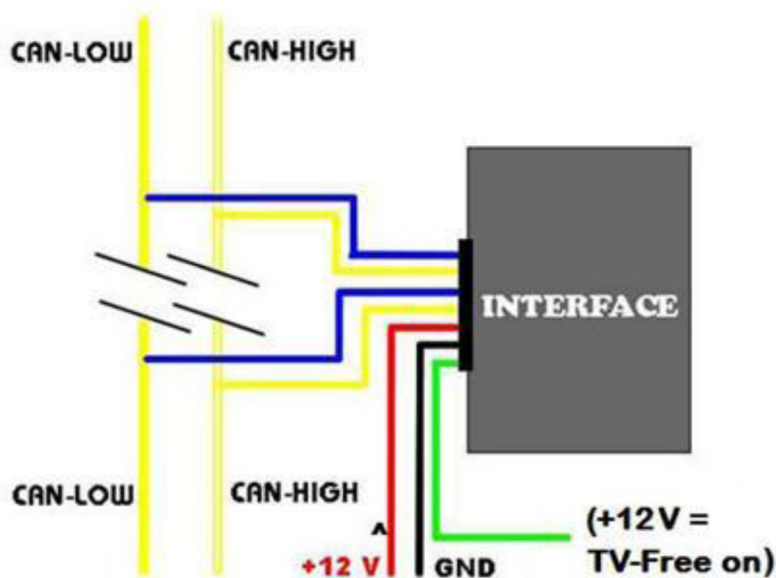

## Vehicles with Audi Navi Plus RNS-E



Place of installation is at the back side of the navigation unit.

*Compatible vehicles*                      Audi A3, A4, TT (8J)

*Attention! Audi A6 with Navi Plus RNS-E have analog speed signal.*

Navi Plus RNS-E

Dip 1 OFF, Dip 2 OFF, Dip 3 OFF



Cable colour	Assignment
● Red/Yellow	+12Volt Permanent 15
● Brown	Ground Pin 12
● Orange/Green	CAN HIGH Pin 9
● Orange/Brown	CAN LOW Pin 10

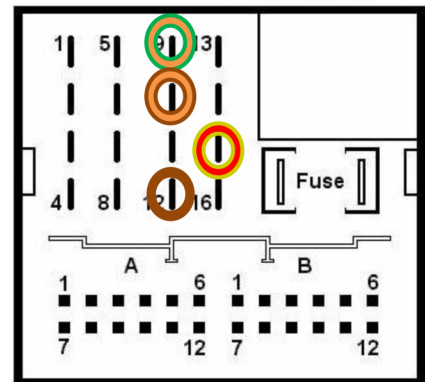

Longpress the „>|“ button (about 5 seconds) to activate/deactivate the video-in-motion function. When ignition is off, the video-in-motion interface will be automatically disabled.



Long blinking of the navigations backlight = TV Free ON  
 Short blinking of the navigations backlight = TV Free OFF

**Note:** While the video-in-motion function is activated, the navigation performance is not possible!

## Vehicles with ZAB



Place of installation is at the back side of the navigation unit.

*Compatible vehicles*

Bentley Continental Coupe, VW Phaeton

All vehicles

Dip 1 ON, Dip 2 OFF, Dip 3 OFF

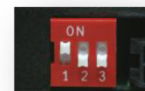

### 32-pin connector

Cable colour	Assignment
● Orange/Green	CAN HIGH Pin 16
● Orange/Brown	CAN LOW Pin 32



### 8-pin power harness

Cable colour	Assignment
● Red	+12V Permanent Pin 7
● Brown	Ground Pin 8

The video-in-motion function is activated permanently without disturbing the navigation performance.

## Vehicles with MYGIG



Place of installation is at the back side of the navigation unit.

<i>Compatible vehicles</i>	Chrysler, Dodge and Jeep, Ferrari California
<i>Navigation</i>	MYGIG RER/REW/REN/REP, REX (Dodge), MYGIG RHW (year 2012)

All vehicles                      Dip 1 ON, Dip 2 OFF, Dip 3 OFF

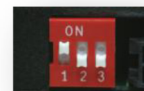

Cable colour	Assignment
○ ● White/Orange	CAN-HIGH - Pin 13
○ White	CAN-LOW - Pin 2
● Red	+12V Permanent - Pin 1
● Black/Green	Ground - Pin 12

The video-in-motion function is activated permanently without disturbing the navigation performance.

## Vehicles with RT3-N3 CAN and RT4



Place of installation is at the back side of the navigation unit.

Compatible vehicles	Citroen, Peugeot
---------------------	------------------

All vehicles	Dip 1 OFF, Dip 2 OFF, Dip 3 OFF
--------------	---------------------------------



Cable colour	Assignment
• White	CAN HIGH Pin 10
• Grey	CAN LOW Pin 13

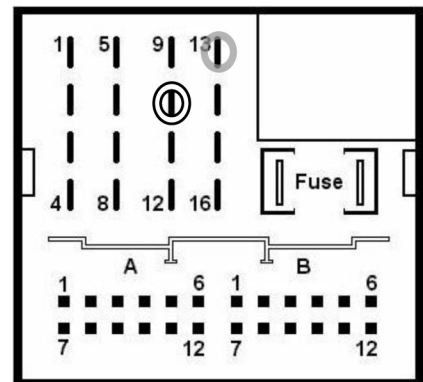

Longpress the "SRC"-button on the steering wheel (about 3 seconds) to activate/deactivate the video-in-motion function. When ignition is off, the video-in-motion interface will be automatically disabled.

**Note:** While the video-in-motion function is activated, the navigation performance is not possible!

## Vehicles with NG4 NaviDrive and NG4 WipCom



Place of installation is at the back side of the navigation unit.

<i>Compatible vehicles</i>	Citroen, Peugeot
<i>Navigation</i>	NG4 NaviDrive (Citroen), NG4 WipCom (Peugeot)

All vehicles Dip 1 ON, Dip 2 OFF, Dip 3 OFF



Cable colour	Assignment
• White	CAN HIGH Pin 10
• Grey	CAN LOW Pin 13

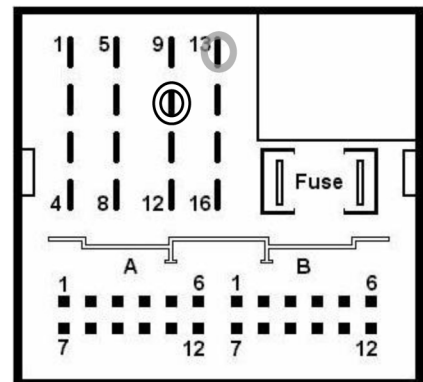

The video-in-motion function is activated permanently without disturbing the navigation performance.

## Ford Edge with MYGIG



Place of installation is at the back side of the navigation unit.

<i>Compatible vehicles</i>	Ford Edge
----------------------------	-----------

All vehicles	Dip 1 ON, Dip 2 OFF, Dip 3 OFF
--------------	--------------------------------

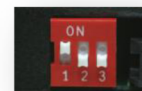

### Connector A

Cable colour	Assignment
● ● Grau/Orange	CAN-HIGH
● ● Violett/Orange	CAN-LOW

### Connector B

Cable colour	Assignment
○ ● White/Red	+12V Permanent
● ● Black/Blue	Ground



Connector A

Connector B

The video-in-motion function is activated permanently without disturbing the navigation performance.

## Jaguar XF



Place of installation is at the back side of the radio module.

<i>Compatible vehicles</i>	Jaguar XF
----------------------------	-----------

WITH factory rear-view camera Dip 1 ON, Dip 2 ON, Dip 3 OFF



WITHOUT factory rear-view camera Dip 1 OFF, Dip 2 ON, Dip 3 OFF



Cable colour	Assignment
● Yellow/Red	+12V Permanent
● Black	Ground
● Grey/Orange	CAN-HIGH
● Purple/Orange	CAN-LOW

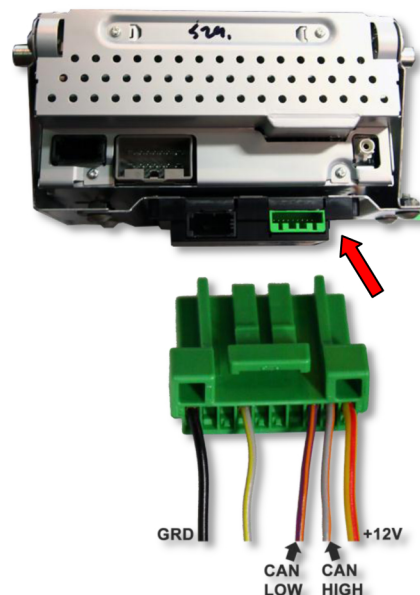

**Attention:** CAN-LOW and CAN-HIGH could be reversed at older vehicles (e.g. Grey/Orange = CAN-LOW)!

The video-in-motion function is activated permanently without disturbing the navigation performance.

## Jaguar XJ (2011)



Place of installation is at the back side of the monitor.

*Compatible vehicles*

Jaguar XJ

All vehicles

Dip 1 ON, Dip 2 ON, Dip 3 OFF



Cable colour	Assignment
● Grey/Red (Pin 8)	+12V Dauerplus
● Black (Pin 5)	Masse
● Grey/Orange (Pin 2)	CAN-HIGH
● Purple/Orange (Pin 1)	CAN-LOW

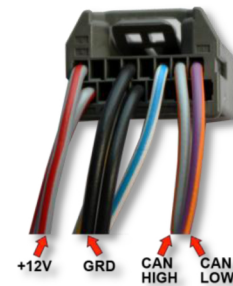

The video-in-motion function is activated permanently without disturbing the navigation performance.

## LandRover 2006-2009



Place of installation is at the back side of the radio module. (a hide-away box which is located behind the glove box or behind the factory navigation monitor).

<i>Vehicle</i>	Range Rover (Vogue), Range Rover Sport, Discovery3/4 <b>till year 2011</b>
<i>Navigation</i>	Touch-screen navigation 1st generation (2006-2009) and 2 <sup>nd</sup> generation (2010-2011)

### For vehicles with navigation 1st generation (2006-2009)



2006-2009

With factory rear-view camera      Dip 1 ON, Dip 2 ON, Dip 3 ON

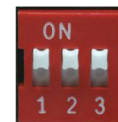

Without rear-view camera or  
with after-market rear-view cam.      Dip 1 OFF, Dip 2 ON, Dip 3 ON



## For vehicles with navigation 2nd generation (2010-2011)



2010-2011

With rear-view camera      Dip 1 ON, Dip 2 ON, Dip 3 ON

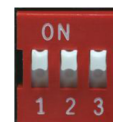

Without rear-view camera      Dip 1 OFF, Dip 2 ON, Dip 3 ON



**Note:** On vehicles from 2010, setting dip 1 to ON codes the factory rear-view camera input which is located on the 6pin male connector of the factory monitor. When reverse gear is engaged, the navigation will automatically switch to this input. On vehicles with factory rear-view camera set Dip 1 to ON, too.

### Range Rover Vogue

Cable colour	Assignment
● Yellow/White	CAN-HIGH Pin 9
● Yellow/Blue	CAN-LOW Pin 10

### Sport & Discovery

Cable colour	Assignment
● Yellow/White	CAN-HIGH
● Yellow	CAN-LOW

The video-in-motion function is activated permanently without disturbing the navigation performance.

## LandRover from 2012



Place of installation is at the back side of the monitor.

<i>Vehicle</i>	Evoque, Range Rover Vogue, Sport, Discovery3/4 <b>from year 2012</b>
<i>Navigation</i>	Touch-Screen Navigation 3 <sup>rd</sup> generation

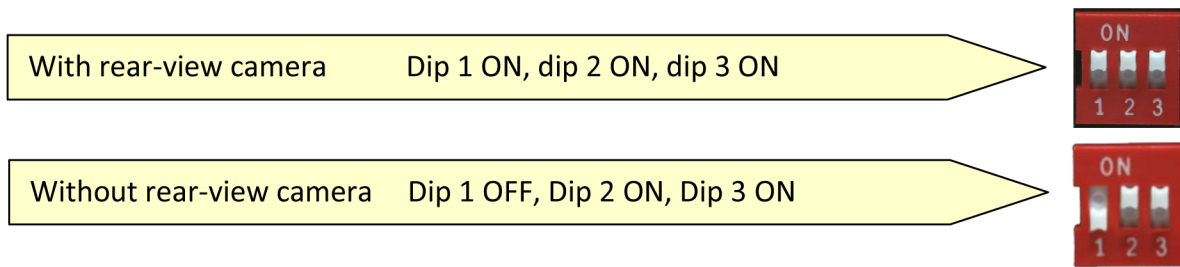

**Note:** Setting dip 1 to ON codes the factory rear-view camera input which is located on the brown Fakra male connector of the factory monitor. When reverse gear is engaged, the navigation will automatically switch to this input. On vehicles with factory rear-view camera set Dip 1 to ON, too.

### Pin-assignment factory monitor connector

Cable colour	Assignment
● Orange/grey	CAN-HIGH Pin 2
● Orange/purple	CAN-LOW Pin 1

The video-in-motion function is activated permanently without disturbing the navigation performance.

## Maserati Quattroporte



Place of installation is at the back side of the navigation unit.

<i>Compatible vehicles</i>	Maserati Quattroporte
----------------------------	-----------------------

All vehicles	Dip 1 ON, Dip 2 OFF, Dip 3 OFF
--------------	--------------------------------



Cable colour	Assignment
● Red/Yellow	+12V Permanent Pin 15
● Brown	Ground Pin 12
● Orange/Purple	CAN-HIGH Pin 9
● Orange/Brown	CAN-LOW Pin 10

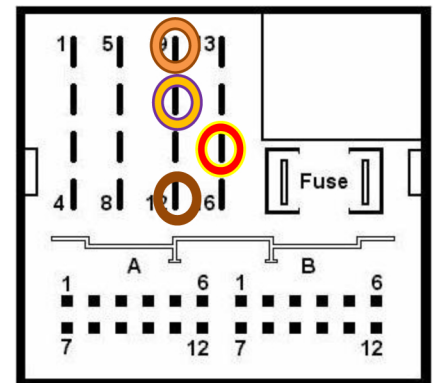

The video-in-motion function is activated permanently without disturbing the navigation performance.

## Vehicles with Mercedes Benz NTG 1



Place of installation is at the AGW-module (Audio-Gate-Way). The AGW-module is placed in the luggage compartment at the left hand side behind the cover of the navigation unit or under the driver seat (SLK R171) or under the front passenger seat (SL R230).

<i>Compatible vehicles</i>	Mercedes Benz CL-Class (C215) from 10/03, S-Class (W220) from 10/03, SL-Class (R230) from 06/04, CLS-Coupe (W219) from 10/04 til approx 04/08, E-Class (W211) til approx 04/08, SLK-Class (R171) from 03/04 til approx 04/08
<i>Navigation</i>	NTG1, Comand APS DVD

All vehicles                      Dip 1 ON, Dip 2 OFF, Dip 3 OFF



Cable colour	Assignment
● Brown/Red	CAN-HIGH Pin 2
● Brown	CAN-LOW Pin 4

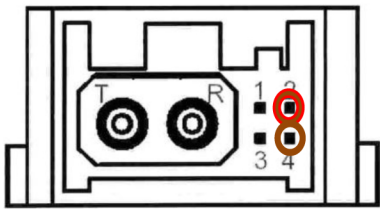

The video-in-motion function is activated permanently without disturbing the navigation performance.

## Vehicles with Mercedes Benz NTG 2, NTG 2.5, NTG 4, NTG 4.5



Place of installation is at the back side of the navigation unit.

**Compatible vehicles** Mercedes Benz A-Class (W169) from 09/04, B-Class (W245) from 09/04, C-Class (W203) from 04/04, CLK-Class (C209 W209) from 06/04, GL-Class (X164), ML-Class (W164) all years, R-Class (W251), Sprinter, Viano, CLS-Coupe (W219) from approx 04/08, E-Class (W211) from approx 04/08, SL-Class from approx 04/08, SLK-Class (R171) from approx 04/08, R-Class (W251) from approx 04/08, ML-Class (W164) from approx 04/08, C-Class (W204) from approx 08/08, GLK-Class (X204), E-Class (W212), E-Class Coupe (W207)

**Navigation** NTG 2, NTG 2.5, NTG 4. NTG 4.5

NTG 2/ 4/ 4.5 Dip 1 ON, Dip 2 OFF, Dip 3 OFF

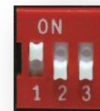

NTG 2.5 Dip 1 ON, Dip 2 OFF, Dip 3 OFF

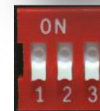

Cable colour	Assignment
● Red/Blue	+12Volt Permanent 15
● Brown	Ground Pin 12
● Brown/Red	CAN HIGH Pin 11
● Brown	CAN LOW Pin 9

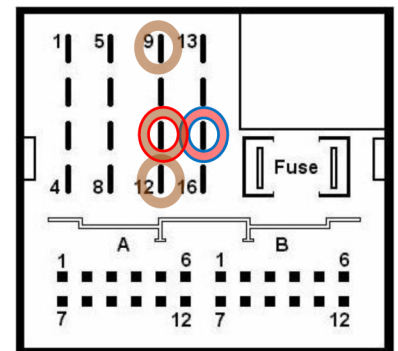

On vehicles with **NTG 2/4/4.5** the video-in-motion function is activated permanently without disturbing the navigation performance.

On vehicles with **NTG 2.5** select the “navigation level” on the instrument and press the “hang-up”-button on the steering-wheel for more than 3 seconds to activate/deactivate the video-in-motion function. When the ignition is off, the video-in-motion interface will be automatically disabled.



**Note:** As long as the video-in-motion function is activated, the navigation of the command **will NOT be working!**

## Vehicles with Mercedes Benz NTG 3 and NTG 3.5



Place of installation is in the centre console behind the DVD unit.

*Compatible vehicles*

Mercedes Benz S-Class (W221) from 10/05, CL-Class (W216), S-Class (W221), CL-Class (W216) with Dual-View

*Navigation*

NTG 3, NTG 3.5

All vehicles

Dip 1 ON, Dip 2 ON, Dip 3 ON



Cable colour	Assignment
● Yellow/White	CAN-HIGH Pin 1
● Yellow	CAN-LOW Pin 11

The video-in-motion function is activated permanently without disturbing the navigation performance.

## Vehicles with Porsche PCM 2.1



Place of installation is at the back side of the navigation unit.

*Compatible vehicles* Cayenne E1

All vehicles Dip 1 ON, Dip 2 OFF, Dip 3 OFF



Cable colour	Assignment
● Red	+12V Dauerstrom Pin 4
● Black	Ground Pin 8
● Orange/Purple	CAN HIGH Pin 1 (Kammer C1)
● Orange/Brown	CAN LOW Pin 2 (Kammer C1)

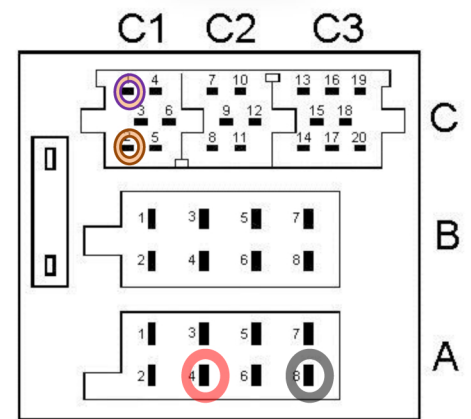

The video-in-motion function is activated permanently without disturbing the navigation performance.

## Vehicles with Porsche PCM 3.0



Place of installation is at the back side of the navigation unit.

**Compatible vehicles**

Cayenne E1, 911, Boxster, Cayman

**Limitations**

Internal DVD video cannot be watched!

With factory rear-view camera

Dip 1 OFF, Dip 2 ON, Dip 3 ON



Without rear-view camera or with after-market rear-view cam.

Dip 1 ON, Dip 2 ON, Dip 3 ON



Cable colour	Assignment
● Red	+12V Permanent Pin 15
● Black	Ground Pin 12
● Orange/Purple	CAN HIGH Pin 11
● Orange/Brown	CAN LOW Pin 9

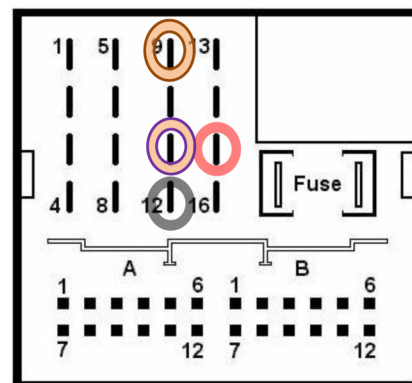

The video-in-motion function is activated permanently without disturbing the navigation performance.

## Vehicles with Porsche PCM 3.1



Place of installation is at the back side of the navigation unit.

**Compatible vehicles** Cayenne E2, Panamera

### Limitations

Internal DVD video cannot be watched!

With factory rear-view camera Dip 1 OFF, Dip 2 ON, Dip 3 ON



Without rear-view camera or with after-market rear-view cam. Dip 1 ON, Dip 2 ON, Dip 3 ON

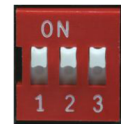

Cable colour	Assignment
● Red	+12V Permanent Pin 15
● Black	Ground Pin 12
● Orange/Purple	CAN HIGH Pin 11
● Orange/Brown	CAN LOW Pin 9

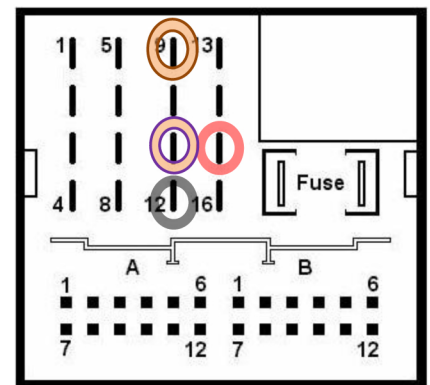

The video-in-motion function is activated permanently without disturbing the navigation performance.

## Volvo with RTI 2011



Place of installation is at the back side of the monitor.

<i>Compatible vehicles</i>	Volvo S-Serie, V-Serie, XC90
<i>Navigation</i>	RTI 2011

All vehicles Dip 1 ON, Dip 2 ON, Dip 3 ON



Cable colour	Assignment
● Purple/Red	+12V Permanent
● Black/Grey	Ground
● Grey/Orange	CAN HIGH Pin 10
● Purple/Orange	CAN LOW Pin 09

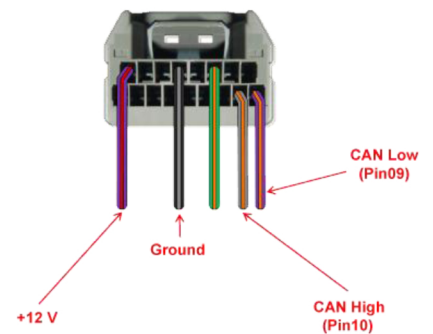

The video-in-motion function is activated permanently without disturbing the navigation performance.

## Vehicles with VW MFD2/RNS2 und Skoda Nexus



Place of installation is at the back side of the navigation unit.

<i>Compatible vehicles</i>	VW Touareg; Golf 5, Touran, T5, Passat from years 2006, Caddy Live, Skoda Octavia 2 and other vehicles with MFD2/RNS2/Nexus navigation systems
<i>Navigation</i>	MFD2, RNS2, Nexus

VW/Skoda MFD2/RNS2/Nexus      Dip 1 ON, Dip 2 OFF, Dip 3 OFF



Cable colour	Assignment
● Red/Yellow	+12V Permanent Pin 15
● Brown	Ground Pin 12
● Orange/Green	CAN HIGH Pin 9
● Orange/Brau	CAN LOW Pin 10

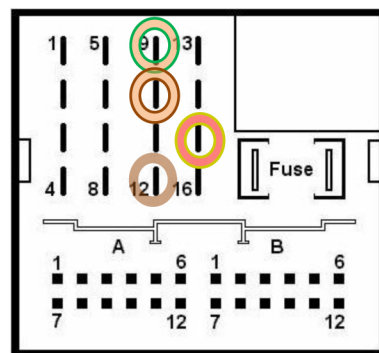

The video-in-motion function is activated permanently without disturbing the navigation performance.

## 3. Specifications

Operation voltage	10.5 – 14.8V
Stand-by power drain	>1mA
Operation power drain	~60mA
Power consumption	~0,72W
Temperature range	-30°C bis +80°C
Weight	44g
Measurements (box only) B x H x T	70 x 20 x 47 mm

